

STORETEQ F-100

Performance tailored to your needs.
Our single-axis feeder

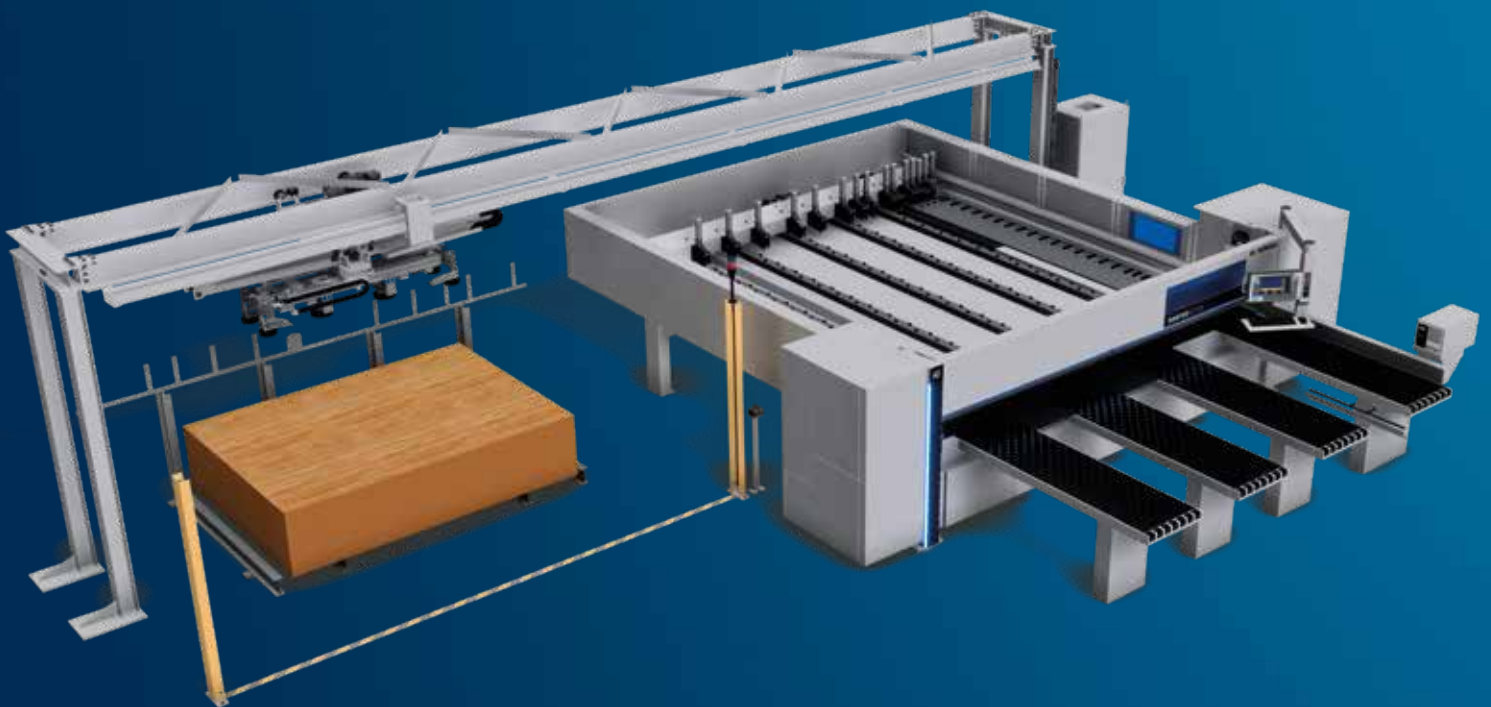



Intelligent loading combination. Save material. Save space.

Efficient, ergonomic, and gentle on material: The new HOMAG STORETEQ F-100 single-axis feeder is a winner right down the line - and with minimal space requirements. Control, including off-cut handling, is particularly intuitive and simple directly at the saw via woodStore software. The gantry uses vacuum suction to fetch the next board just-in-time from the stacking area next to or behind the saw, rotates the material as needed, and places it in the saw. Everything is fully automatic.

YOUR SOLUTION

MORE AT HOMAG.COM



STORETEQ F-100

CONTENTS

- 04 STORETEQ F-100
- 06 Variants
- 08 Control system
- 09 Software
- 10 Technical data
- 11 Service

Clever and variable

The STORETEQ F-100 provides even more efficiency and flexibility in panel dividing - gentle on the material, automatic and fast. With its newly developed layout concept, the STORETEQ F-100 does not require any additional intermediate suspensions or cross bracing for a span of up to 12 m – for optimum space utilization in your production.

BASIC EQUIPMENT

- Basic frame in gantry design
- Movable lifting device with suction crossbeam
- Turning unit – rotatable up to 90 degrees
- Automatic weight detection
- Automatic length adjustment of the suction crosshead

ADDITIONAL EQUIPMENT

- Stacking positions available in 3,200 mm or 4,200 mm board length
- Additional storage places possible
- Expandable up to 8 stations, of which
 - maximum 3 processing machines
 - maximum 4 storage places
- Additional control panel for several integrated machines

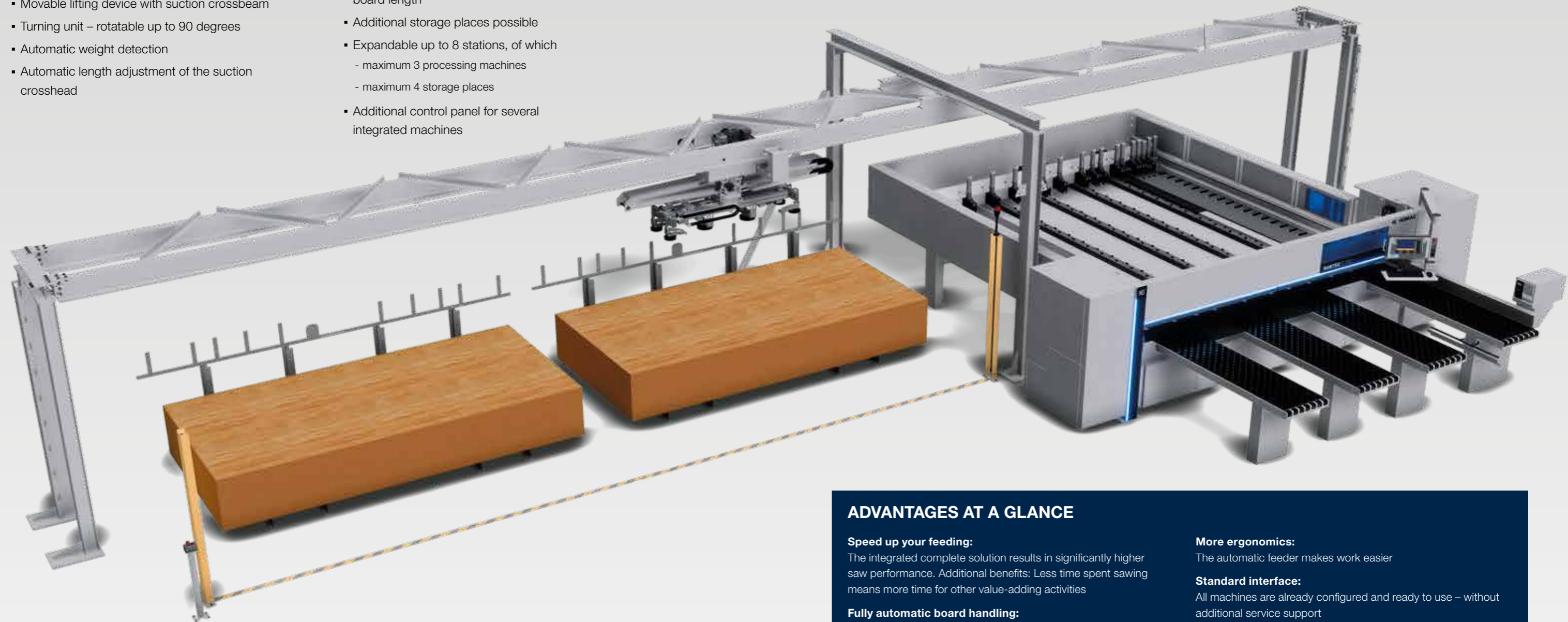

ADVANTAGES AT A GLANCE

Speed up your feeding:

The integrated complete solution results in significantly higher saw performance. Additional benefits: Less time spent sawing means more time for other value-adding activities

Fully automatic board handling:

A continuous process flow increases your productivity and saves time

Optimized transport:

The single-axis feeder ensures your panel quality

Fits in any workshop:

The space-optimized feeder requires hardly any floor space

More ergonomics:

The automatic feeder makes work easier

Standard interface:

All machines are already configured and ready to use – without additional service support

Intuitive operation:

You operate the feeder conveniently via woodStore directly at the saw

Space-saving modularity

With the STORETEQ F-100, you determine where the stacking stations are located - individually adapted to your processes in cutting. This allows you to put together layouts that are individually tailored to your requirements. The HOMAG STORETEQ F-100 single-axis feeder is available in various expansion stages and grows with your requirements. One or more machines as well as several stacking stations can be integrated.

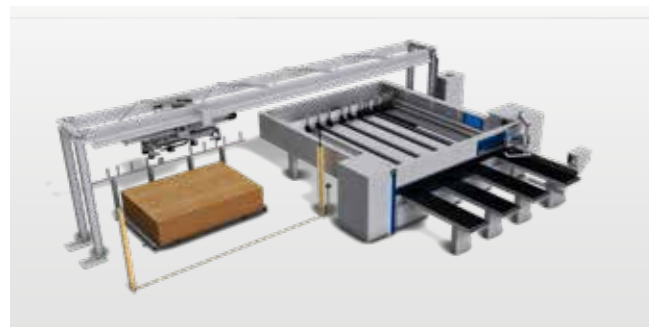

STORETEQ F-100 Layout A

- A-Left (1 place left)
- A-Right (1 place right)
- AA (1 place each left and right)

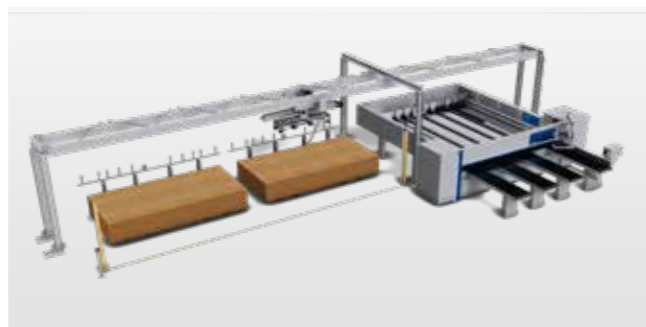

STORETEQ F-100 Layout B

- 2 places left



STORETEQ F-100 Layout C

- 2 places right



STORETEQ F-100 Layout D

- 1 place at the back

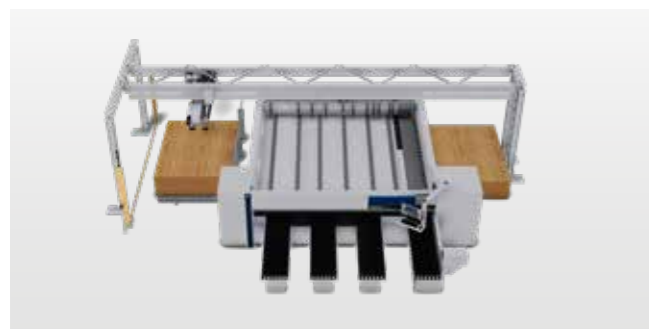

STORETEQ F-100 Layout E

- E-Left (1 place left)
- E-Right (1 place right)

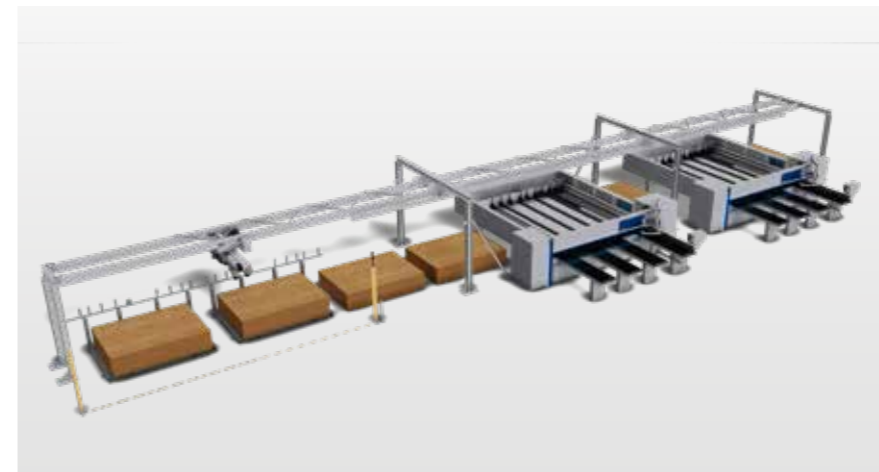

STORETEQ F-100 Layout F

- 6 places
- several processing machines
- additional operating terminal



STORETEQ F-100 Layout G

- 5 places
- several processing machines
- additional operator terminal



Additional operator terminal

- for integration of several processing machines
- when integrating a nesting machine or third-party products

Control system

Operation directly at the processing machine is particularly intuitive and simple with the standardized powerTouch control system from HOMAG. The advantage: In combination with a SAWTEQ from HOMAG, no additional operating terminal is required. The proven woodStore storage software runs in the background, ensuring smooth loading of the saw or nesting machine. In conjunction with the processing machine, this creates a complete production cell – including off-cut management.

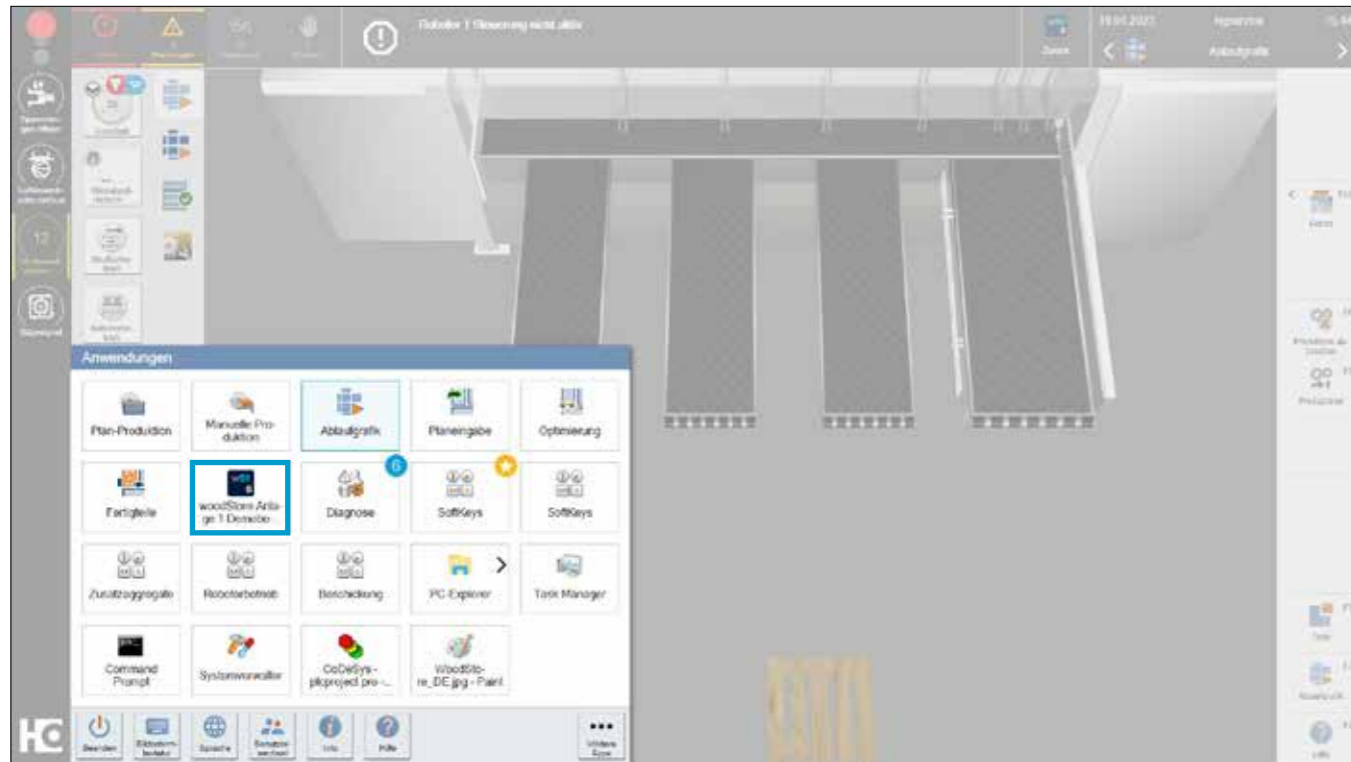

An investment that pays off

- Performance simulation of your planned production during the quotation phase
- Simulation results optimized to reduce loading times



Illustrations may show the technical principle but not the precise machine type described. Optional features, for example, may be shown.

Smart & flexibly scalable

The software of the STORETEQ F-100 single-axis feeder grows with your requirements and becomes more intelligent without the operator having to intervene in a time-consuming way. The simplest variant is to place the stack in the storage bin, give the start signal to the processing machine and you're ready to go.

Other highlights of the single-axis feeder:

- Manual off-cut management – Cost savings through optimum material utilization.
- Restacking function – time savings through intelligent presorting for production
- Working with job lists – no manual input of stack information for even more efficient production
- Optimization data can be easily imported – due to the integration in the processing machine no additional data for the STORETEQ F-100 have to be generated.

Simple and intuitive operation

- Double-click on the storage bin and the storage starts
- Alternatively: "Fill stacks" via the Start editing menu

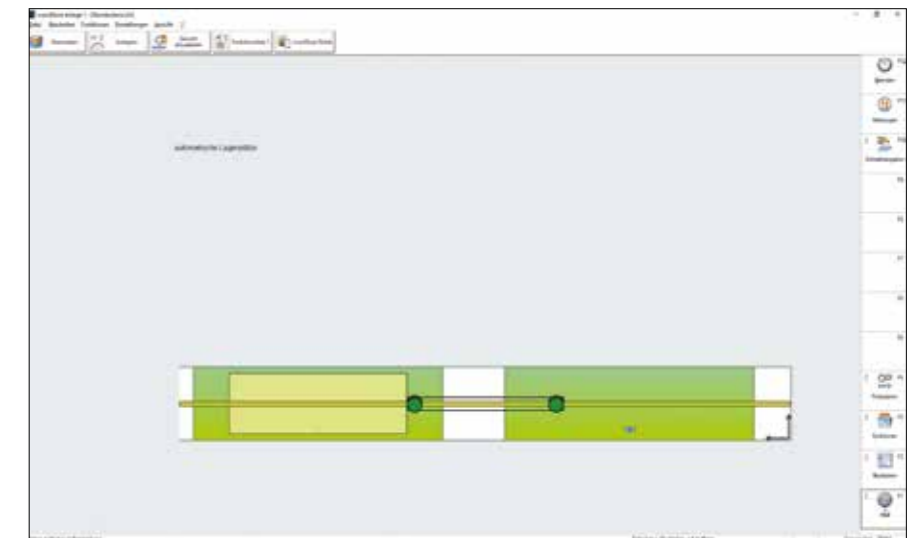

EVERYTHING UNDER CONTROL WITH MAXIMUM TRANSPARENCY

MMR basic

With MMR basic you get an overview of the performance of your STORETEQ F-100 – so you always have all the relevant machine information with you wherever you are.

MachineBoard

The MachineBoard clearly shows the remaining running times cycle of the STORETEQ F-100 for continuous tracking of your production. continuous tracking of your production.

TECHNICAL DATA	
Model	STORETEQ F-100
Panel size stacking space	3200 x 2200 mm 4200 x 2200 mm
Panel length	2000 mm to 4200 mm
Panel width	600 mm to 2200 mm
Panel thickness coated	8 mm to 40 mm
Individual weight of panels	max. 250 kg
Stacking height	max. 1800 mm (optionally 2100 mm)
carriage	80 m/min
Lifting drive	25 m/min

VALYOU

Our Mission, Your Performance.

Fast support:
94% resolution rate
via our hotline

Close to you:
1,350 service experts worldwide

We get things moving:
Over 1,000 worldwide spare parts
shipments each day

No one else has that:
Electronic documentation on over
150,000 machines, available in 28
languages



LIFE CYCLE SERVICES

Improved performance, more efficient processes, faster help, assurance of availability and smarter working.
VAL YOU comes from VALUE ADDED. Our objective is derived from this name: We create added value for your business by helping you get the most out of your processes. Every day.



HOMAG Group AG

info@homag.com
www.homag.com

YOUR SOLUTION